

Waste Ø 90

Garantie  
**5**  
ANS

INNOVATION  
WIRQUIN



## SLIM RANGE

► Specially designed for EXTRA-FLAT trays with higher flow rates than the standard requirements.

# Discover the new SLIM range



SLIM EXPERT

SLIM METAL DOME

SLIM SHOWER



The SLIM range is specially designed to be fitted to the flattest trays on the market, in Ø 90 thanks to its low height:

**ONLY 40 MM!**

The silicon membrane guarantees excellent flow rates and totally stops smells coming up.



**40 mm**



Shower wastes

**EXTRA-PLATES**

**wirquin**  
**PRO**

EXPERT EN ÉQUIPEMENT SANITAIRE

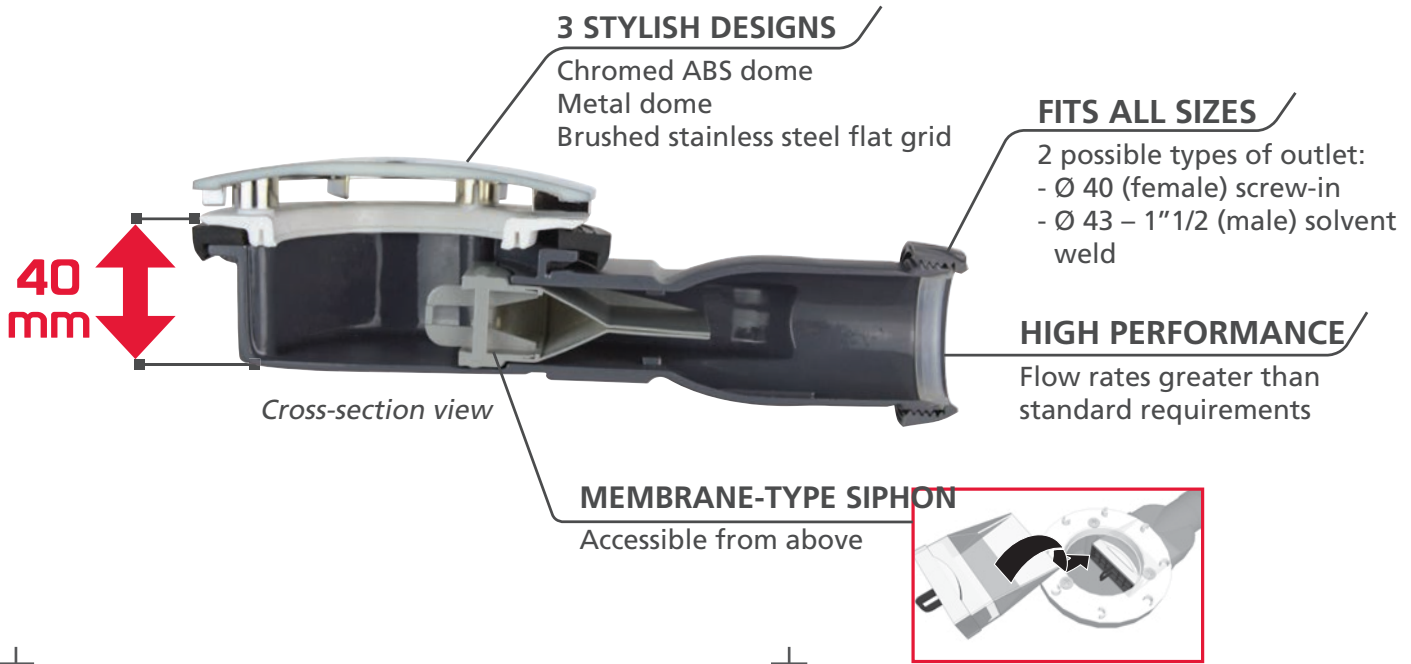

### ADVANTAGES OF A MEMBRANE-TYPE SIPHON

- Anti back-siphoning system.
- No smell guarantee: the membrane replaces the water trap.
- Easy to maintain: the membrane is removable, accessible from above and is fitted with a hair filter.
- High performance flow rate.

### ► Flow rates meet the requirements of standard NF EN274

#### SLIM SHOWER

FLOW RATE IN 15 MM OF WATER 33.6 L/min

FINISH CHROMED ABS dome

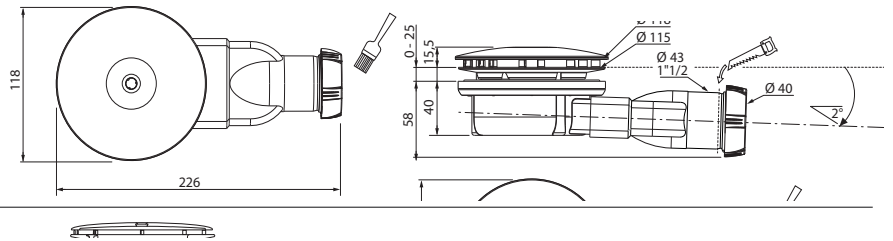

#### SLIM METAL DOME

FLOW RATE IN 15 MM OF WATER 28 L/min

FINISH Metal dome

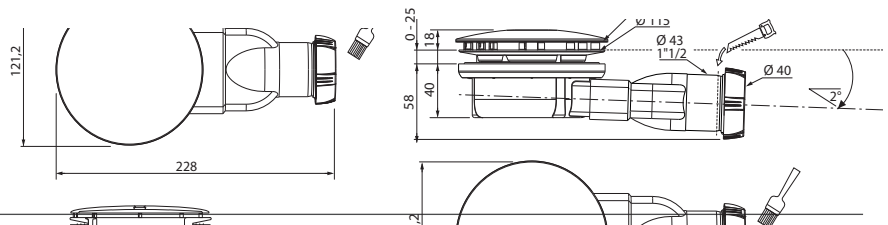







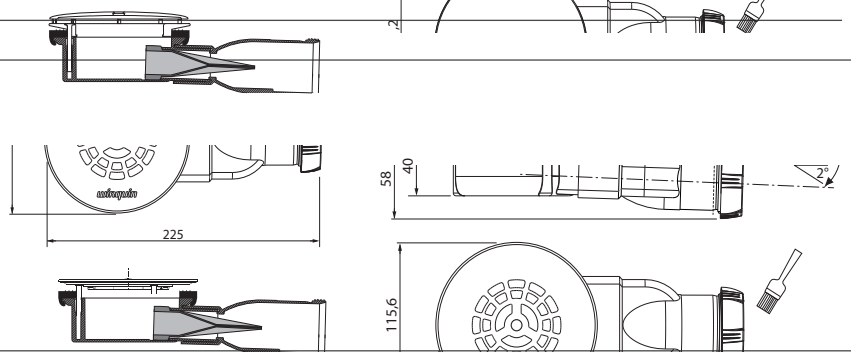



#### SLIM EXPERT

FLOW RATE IN 15 MM OF WATER 27 L/min

FINISH Stainless steel finish flat grid



	1 Dome	2 Screws	3 Adaptor	4 Adaptor for stoneware tray
<b>SLIM SHOWER</b> 	 chromed ABS	M4 x 40 mm Stainless steel	 PA66+FG White	Only available in this version
<b>SLIM METAL DOME</b> 	 Chromed Metal	M4 x 40 mm Stainless steel	 POM White	
<b>SLIM EXPERT</b> 	 Brushed STAINLESS STEEL	M4 x 40 mm Stainless steel	 304L STAINLESS STEEL Chromed	

PP: Polypropylene  
LDPE: Low Density Polyethylene  
PA6.6 + FG: Polyamide 6.6 + Fibreglass  
POM: Acetal

Ref.	Description	Quantity	Material	Colour
5	Ø 115 Seal	1	SBS 25 Sh A	Grey
6	Insert for M4 screw	3	Brass	-
7	Ø 90 waste body	1	ABS	Grey
8	Filter	1	POM	Grey
9	Silicon membrane	1	Silicon	Grey
10	Drain tube	1	ABS	Grey
11	Ø40 conical seal	1	LDPE	Natural
12	1"1/2 nut	1	PP	Grey

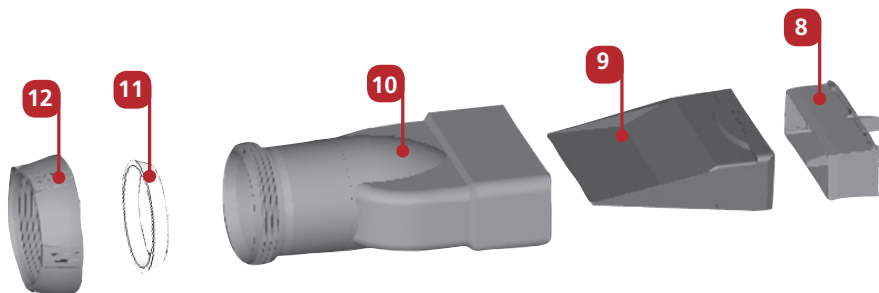
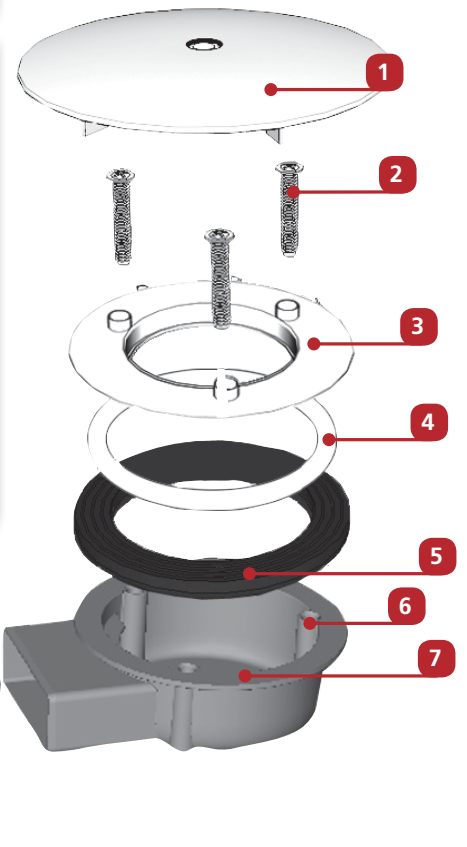

### TIP:

For stoneware trays or trays with conical drain holes in the ABS dome version only, a special adaptor is provided (in the **SLIM ABS DOME** pack only).

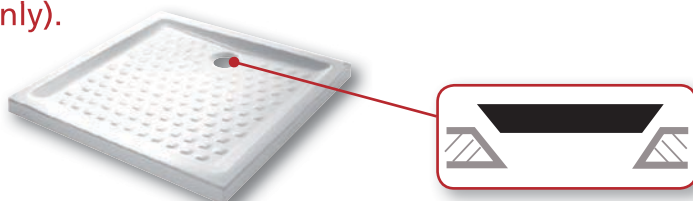

### SLIM SHOWER: FOR ALL TYPES OF SHOWER TRAYS Ø 90

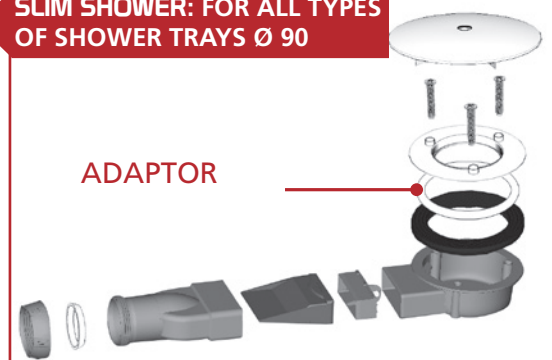

# A complete range

## SLIM EXPERT



## SLIM METAL DOME



## SLIM SHOWER



Description	Finish	Reference	EAN code	Packaging	Multiple/ Boxed quantity	Price
SLIM EXPERT	Brushed stainless steel grid	-	-	Box	1/24	-
SLIM METAL DOME	Metal dome	-	-	Box	1/24	-
SLIM SHOWER	Chromed ABS dome	-	-	Box	1/24	-

Ø 90 Waste

Garantie  
**5**  
ANS

INNOVATION  
WIRQUIN



## SLIM RANGE

► *Specially designed for EXTRA-FLAT shower trays with higher flow rates than the standard requirements!*



SLIM for Shower Deck



SLIM SHOWER

The SLIM range is specially designed to be fitted to the flattest trays on the market, in Ø 90 thanks to its low height:

**ONLY 40 MM!**



**40 mm**

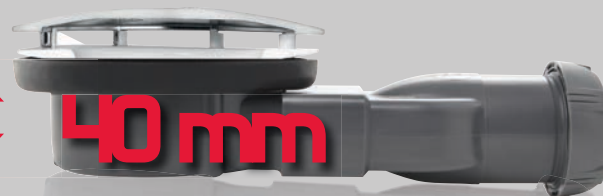

Shower wastes

**EXTRA FLAT**

**wirquin**  
**PRO**

EXPERT EN ÉQUIPEMENT SANITAIRE

# SLIM RANGE

## ▶ Extra-flat wastes!

▶ Thanks to its many versions, the SLIM range can be fitted to all extra-flat shower trays on the market, whether they are stoneware, synthetic or design.

### SLIM MEMBRANE

#### 2 FINISHES

Chromed ABS dome  
Stainless steel ring

#### FITS ALL SIZES

3 possible types of outlet:  
- Ø 40 (female) compression  
- Ø 43 – 1"1/2 (male) solvent weld  
- Ø 50 (male) for solvent weld or push-fit connection

40 mm

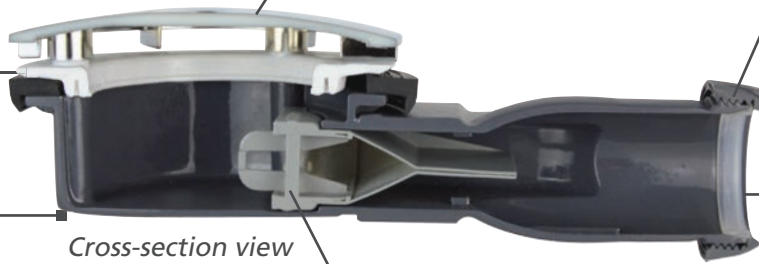

Cross-section view

#### VERSION

Membrane

#### HIGH PERFORMANCE

Flow rates greater than standard requirements

### ADVANTAGES OF A MEMBRANE-TYPE SIPHON

- ▶ Anti back-siphoning system.
- ▶ No smell guarantee: the membrane replaces the water trap.
- ▶ Easy to maintain: the membrane is removable, accessible from above and is fitted with a hair filter.
- ▶ High performance flow rate.

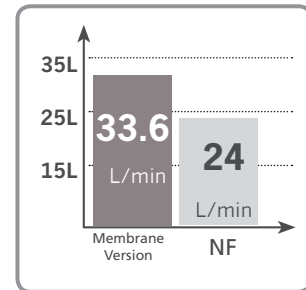

### SLIM TRAP

#### FINISH

Chromed ABS dome

#### FITS ALL SIZES

3 possible types of outlet:  
- Ø 40 (female) compression  
- Ø 43 – 1"1/2 (male) solvent weld  
- Ø 50 (male) for solvent weld or push-fit connection

40 mm

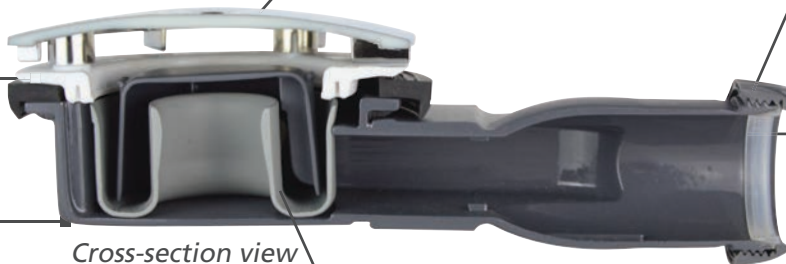

Cross-section view

#### VERSION

Trap

#### HIGH PERFORMANCE

Flow rates greater than standard requirements

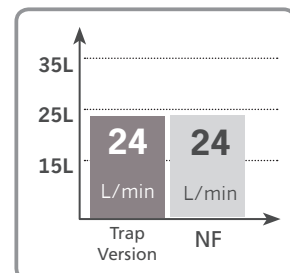

### INSTALLATION

Thanks to its very small overall size, the SLIM range is perfectly suited to facilities giving improved access to Persons of Reduced Mobility (PRM).

# SLIM TRAY<sup>\*</sup> MEMBRANE VERSION

► For DESIGN TRAYS



## ► SLIM TRAY WITH MEMBRANE

### CONNECTOR

Ø 40 compression  
Ø 43 (1" 1/2) to solvent weld or for push-fit connection

### REFERENCE

-

### EAN CODE

-

### FLOW RATE IN 15 MM OF WATER

33.6 L/min

### WATER-PROOFING

The flanged washer guarantees perfect water-proofing

### SAFETY

The stainless steel reinforcing ring guarantees optimum securing using 3 stainless steel screws

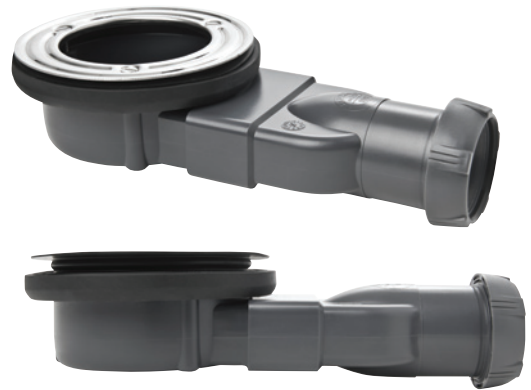

### SIDE-VIEW DIAGRAM

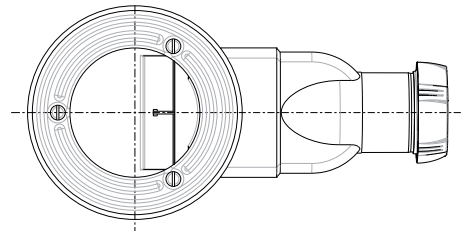
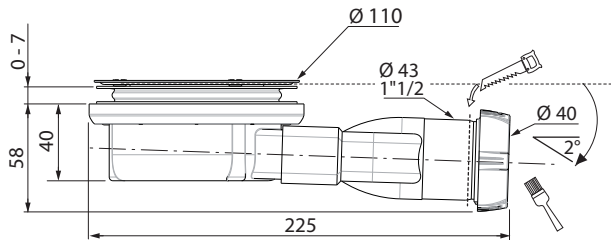

## ► Flow rates meet the requirements of standard NF EN274

Ref.	Description	Quantity	Material	Colour
1	M4 x 40 mm slotted countersunk head metal screw	3	Stainless steel	-
2	Reinforcing ring:	1	304L stainless steel	-
3	Flanged washer	1	SBS 25 Sh A	Black
4	Metal insert	3	Brass	-
5	Ø 90 mm waste body	1	ABS	Grey
6	Filter	1	POM	Grey
7	Silicon membrane	1	Silicon	Grey
8	Drain tube	1	ABS	Grey
9	Ø 40 mm conical washer	1	LDPE	Natural
10	1" 1/2 nut	1	PP	Grey

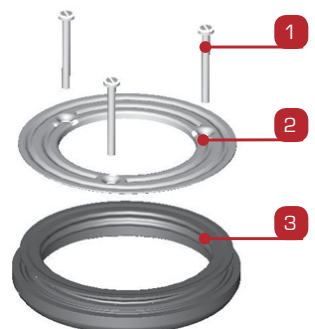

PP: Polypropylene  
LDPE: Low Density Polyethylene  
POM: Acetal

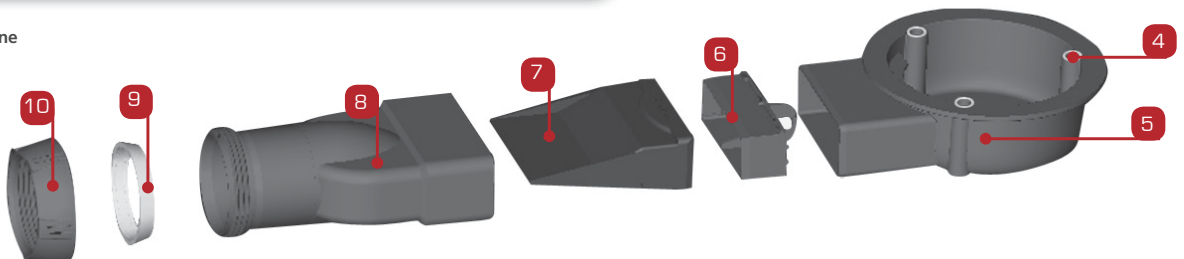

\* Sold without grid

# SLIM SHOWER MEMBRANE VERSION

► For SYNTHETIC trays



## ► SLIM SHOWER WITH MEMBRANE

### CONNECTOR

Ø 40 compression  
Ø 43 (1" 1/2) to solvent weld or for push-fit connection

### REFERENCE

-

### EAN CODE

-

### FLOW RATE IN 15 MM OF WATER

33.6 L/min

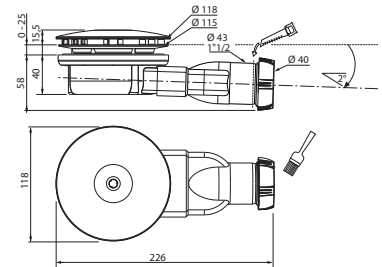

### CONNECTOR

Ø 43 (1" 1/2) compression  
Ø 50 to solvent weld or for push-fit connection

### REFERENCE

-

### EAN CODE

-

### FLOW RATE IN 15 MM OF WATER

33.6 L/min

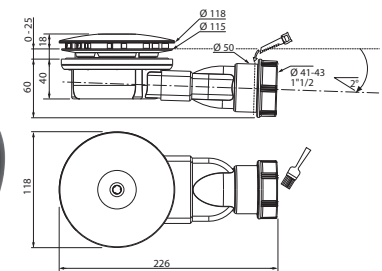
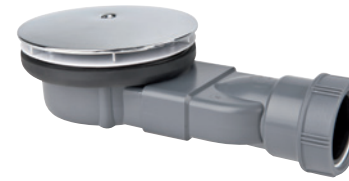

## ► Flow rates meet the requirements of NF EN274 standard

Ref.	Description	Quantity	Material	Colour
1	Dome	1	ABS	Chrome-plated
2	M4 x 40 mm screw	3	Stainless steel	-
3	Adaptor	1	PA66+FG	White
4	Washer Ø 115	1	SBS 25 Sh A	Grey
5	Insert for M4 screw	3	Brass	-
6	Ø 90 mm waste body	1	ABS	Grey
7	Filter	1	POM	Grey
8	Silicon membrane	1	Silicon	Grey
9	Drain tube	1	ABS	Grey
10	Ø 40 mm conical washer	1	LDPE	Natural
11	1" 1/2 nut	1	PP	Grey
12	Ø 50 mm drain tube	1	ABS	Grey
13	Ø 41/43 conical washer	1	EPDM	Black
14	Anti-extrusion ring	1	PP	White
15	1" 3/4 nut	1	PP	Grey

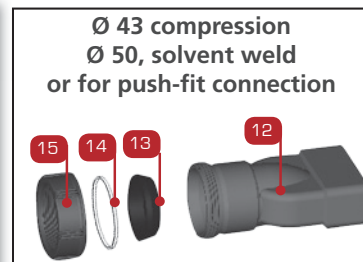

PP: Polypropylene  
LDPE: Low Density Polyethylene  
PA6.6 + FG: Polyamide 6.6 + Fibreglass  
POM: Acetal

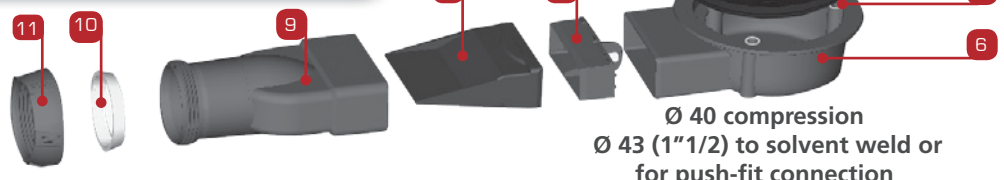

Ø 40 compression  
Ø 43 (1" 1/2) to solvent weld or  
for push-fit connection



# SLIM SHOWER TRAP VERSION

► For SYNTHETIC trays



## SLIM SHOWER WITH TRAP

### CONNECTOR

Ø 40 compression  
Ø 43 (1" 1/2) to solvent weld or for push-fit connection

### REFERENCE

-

### EAN CODE

-

### FLOW RATE IN 15 MM OF WATER

33.6 L/min

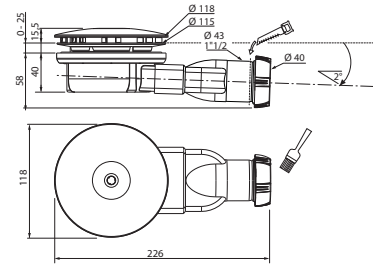

### CONNECTOR

Ø 43 (1" 1/2) compression  
Ø 50 to solvent weld or for push-fit connection

### REFERENCE

-

### EAN CODE

-

### FLOW RATE IN 15 MM OF WATER

33.6 L/min

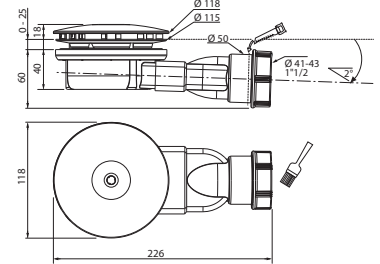
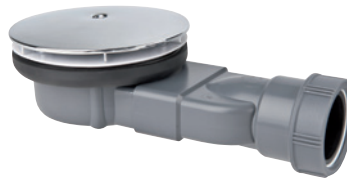

## ► Flow rates meet the requirements of NF EN274 standard

Ref.	Description	Quantity	Material	Colour
1	Dome	1	ABS	Chrome-plated
2	Bell	1	PP	Grey
3	Trap	1	PP	Grey
4	M4x40 mm screws	3	Stainless steel	White
5	Adaptor	1	PA66+FG	White
6	Ø 115 mm washer	1	SBS 25 Sh A	Grey
7	Insert for M4 screws	3	Brass	Grey
8	D90 waste body	1	ABS	Grey
9	Ø 40 mm drain tube	1	ABS	Grey
10	Ø 40 mm conical washer	1	LDPE	Natural
11	1" 1/2 nut	1	PP	Grey
12	Ø 50 mm drain tube	1	ABS	Grey
13	Ø 41/43 mm conical washer	1	EPDM	Black
14	Anti-extrusion ring	1	PP	White
15	1" 3/4 nut	1	PP	Grey

Ø 43 compression or solvent weld  
Ø 50, solvent weld  
or for push-fit connection

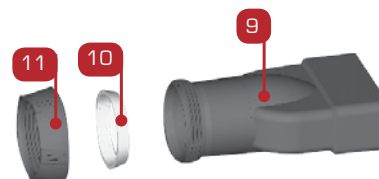
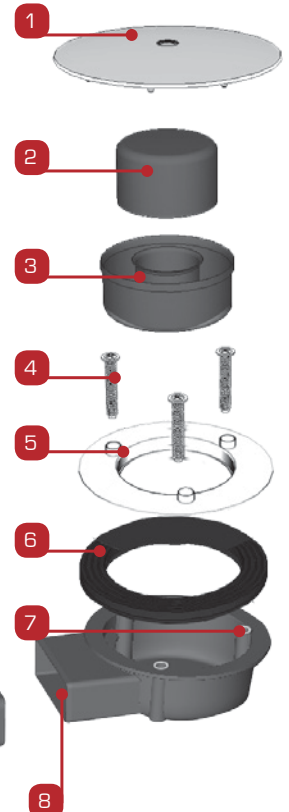
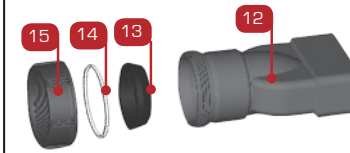

Ø 40 compression  
Ø 43 (1" 1/2) to solvent weld or  
for push-fit connection

PP: Polypropylene  
LDPE: Low Density Polyethylene  
PA6.6 + FG: Polyamide 6.6 + Fibreglass  
POM: Acetal  
EPDM: Ethylene Propylene Diene Monomer

# SLIM SHOWER MEMBRANE VERSION

► For STONEWARE shower trays



## ► SLIM SHOWER WITH MEMBRANE

### CONNECTOR

Ø 40 compression  
Ø43 (1" 1/2) to solvent weld or for push-fit connection

### REFERENCE

-

### EAN CODE

-

### FLOW RATE IN 15 MM OF WATER

33.6 L/min

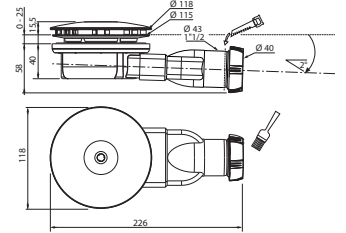

### CONNECTOR

Ø 43 (1" 1/2) compression  
Ø 50 to solvent weld or for push-fit connection

### REFERENCE

-

### EAN CODE

-

### FLOW RATE IN 15 MM OF WATER

33.6 L/min

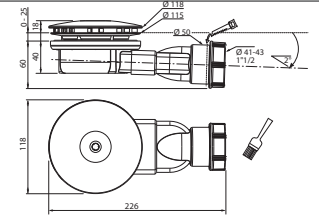
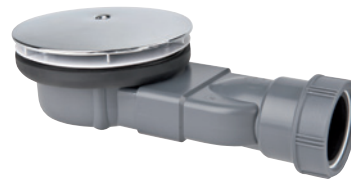

### CONNECTOR

Ø 50 to solvent weld or for push-fit connection

### REFERENCE

-

### EAN CODE

-

### FLOW RATE IN 15 MM OF WATER

33.6 L/min

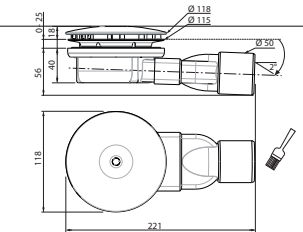

## ► Flow rates meet the requirements of standard NF EN274

Ref.	Description	Quantity	Material	Colour
1	Dome	1	ABS	Chrome-plated
2	M4 x 40 mm screws	3	Stainless steel	-
3	Adaptor	1	PA66+FG	White
4	Adaptor for stoneware tray	1	POM	White
5	Washer Ø 115	1	SBS 25 Sh A	Grey
6	Insert for M4 screws	3	Brass	-
7	Ø 90 waste body	1	ABS	Grey
8	Filter	1	POM	Grey
9	Silicon membrane	1	Silicon	Grey
10	Ø 40 mm drain tube	1	ABS	Grey
11	Ø 40 mm conical washer	1	LDPE	Natural
12	1" 1/2 nut	1	PP	Grey
13	Ø 50 mm drain tube	1	ABS	Grey
14	Ø 41/43 mm conical washer	1	EPDM	Black
15	Anti-extrusion ring	1	PP	White
16	1" 3/4 nut	1	PP	Grey

Ø 43 compression or solvent weld  
Ø 50, solvent weld  
or for push-fit connection

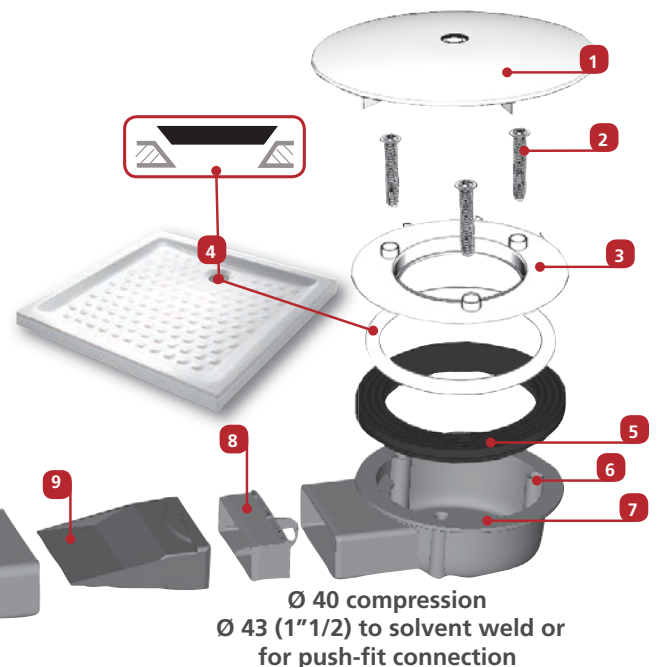
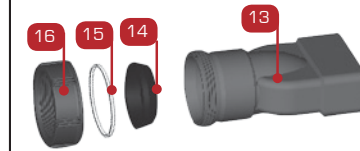

PP: Polypropylene  
LDPE: Low Density Polyethylene  
PA6.6 + FG: Polyamide 6.6 + Fibreglass  
POM: Acetal  
EPDM: Ethylene Propylene Diene Monomer

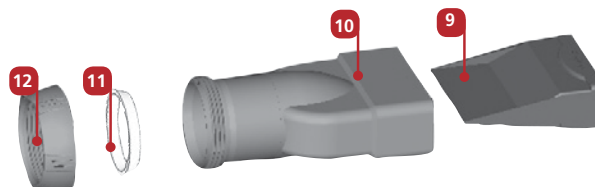

Ø 40 compression  
Ø 43 (1" 1/2) to solvent weld or  
for push-fit connection

# SLIM SHOWER TRAP VERSION

► For STONEWARE shower trays



## ► SLIM SHOWER WITH TRAP

### CONNECTOR

Ø 40 compression  
Ø 43 (1"1/2) to solvent weld or for push-fit connection

### REFERENCE

-

### EAN CODE

-

### FLOW RATE IN 15 MM OF WATER

24 L/min

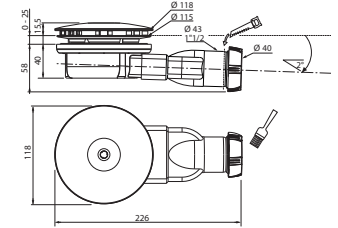

### CONNECTOR

Ø 43 (1"1/2) compression  
Ø 50 to solvent weld or for push-fit connection

### REFERENCE

-

### EAN CODE

-

### FLOW RATE IN 15 MM OF WATER

24 L/min

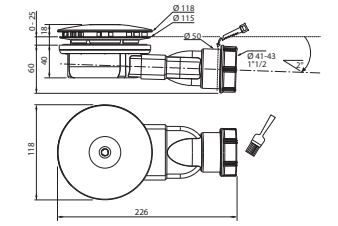
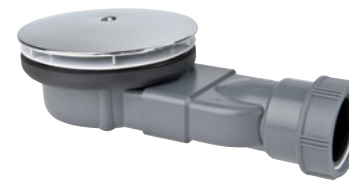

### CONNECTOR

Ø 50 to solvent weld or for push-fit connection

### REFERENCE

-

### EAN CODE

-

### FLOW RATE IN 15 MM OF WATER

24 L/min

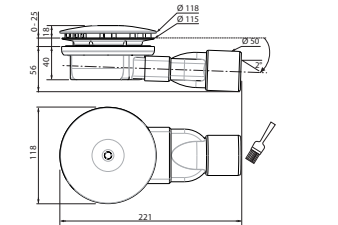

## ► Flow rates meet the requirements of standard NF EN274

Ref.	Description	Quantity	Material	Colour
1	Dome	1	ABS	Chrome-plated
2	Bell	1	PP	Grey
3	Trap	1	PP	Grey
4	M4x40 mm screws	3	Stainless steel	-
5	Adaptor	1	PA66+FG	White
6	Adaptor for stoneware tray	1	POM	White
7	Ø 115 mm washer	1	SBS 25 Sh A	Grey
8	Insert for M4 screws	3	Brass	Grey
9	D90 waste body	1	ABS	Grey
10	Ø 40 mm drain tube	1	ABS	Grey
11	Ø 40 mm conical washer	1	LDPE	Natural
12	1"1/2 nut	1	PP	Grey
13	Ø 50 mm drain tube	1	ABS	Grey
14	Ø 41/43 mm conical washer	1	EPDM	Black
15	Anti-extrusion ring	1	PP	White
16	1"3/4 nut	1	PP	Grey

Ø 43 compression or solvent weld  
Ø 50, solvent weld  
or for push-fit connection

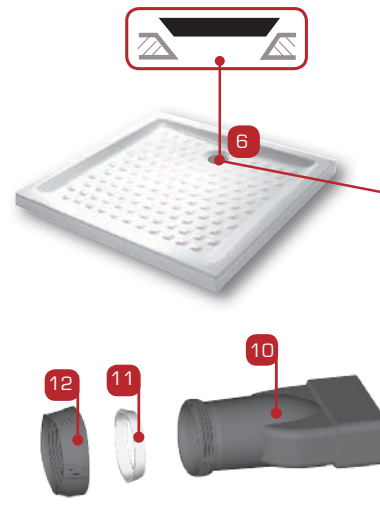
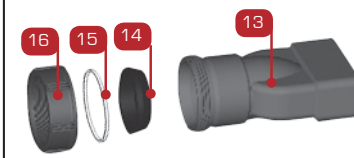

Ø 40 compression or solvent weld  
Ø 43 (1"1/2) to solvent weld or  
for push-fit connection

PP: Polypropylene  
LDPE: Low Density Polyethylene  
PA6.6 + FG: Polyamide 6.6 + Fibreglass  
POM: Acetal  
EPDM: Ethylene Propylene Diene Monomer